



**TS861
TS862
TS864**

RAIL TO RAIL MICROPOWER BICMOS COMPARATORS

- ULTRA LOW CURRENT CONSUMPTION (**6 μ A/comp at V_{CC}=2.7V**)
- RAIL TO RAIL CMOS INPUTS
- PUSH PULL OUTPUTS
- SUPPLY OPERATION FROM **2.7V TO 10V**
- LOW PROPAGATION DELAY
- LOW FALL AND RISE TIME: 20ns
- ESD PROTECTION (**2kV**)
- LATCH-UP IMMUNITY (**Class A**)
- AVAILABLE IN **SOT23-5 MICROPACKAGE**

DESCRIPTION

The TS86x (Single, Dual & Quad) is a Rail to Rail comparator characterized for 2.7V to 10V operation over -40°C to +85°C temperature range. It exhibits an excellent speed to power ratio, featuring a current consumption of 6 μ A per comparator and a response time of 500ns at 2.7V for 100mV overdrive.

Due to its ultra low power consumption and its availability in tiny package, the TS86x comparator family is perfectly suited to battery powered systems. The output stage is designed with a push pull structure allowing a direct connection to microcontroller without additional pull-up resistor.

APPLICATION

- Battery-powered systems (eg: Alarm)
- Portable communication systems
- Smoke/gas/fire detectors
- Portable computers

ORDER CODE

Part Number	Temperature Range	Package				SOT23 Marking
		N	D	P	L	
TS861I TS861AI	-40, +85°C	•	•		•	K501 K502
TS862I TS862AI	-40, +85°C	•	•	•		
TS864I TS864AI	-40, +85°C	•	•	•		

N = Dual in Line Package (DIP)
D = Small Outline Package (SO) - also available in Tape & Reel (DT)
P = Thin Shrink Small Outline Package (TSSOP) - only available in Tape & Reel (PT)
L = Tiny Package (SOT23-5) - only available in Tape & Reel (LT)

PIN CONNECTIONS (top view)

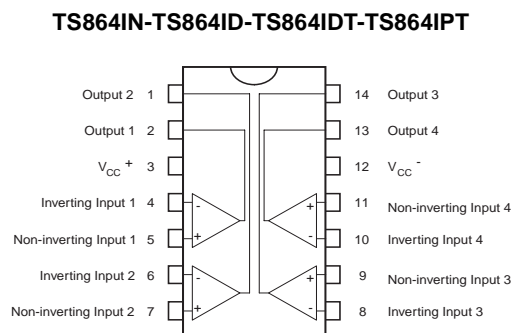
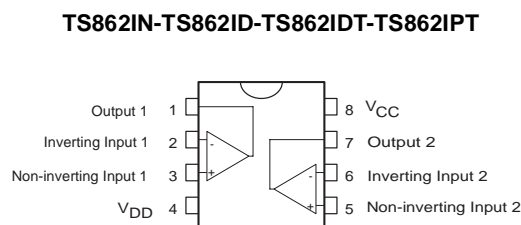
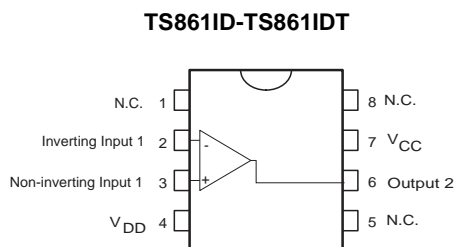
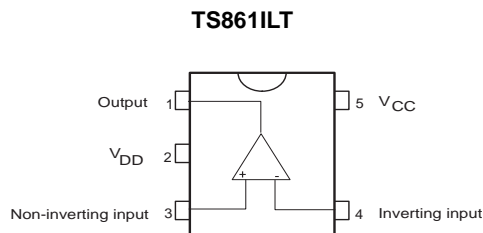

ABSOLUTE MAXIMUM RATINGS

Symbol	Parameter	Value	Unit
V_{CC}	Supply voltage ¹⁾	12	V
V_{id}	Differential Input Voltage ²⁾	± 12	V
V_{in}	Input Voltage Range ³⁾	-0.3 to 12.3	V
T_{std}	Storage Temperature Range	-65 to +150	°C
T_j	Maximum Junction Temperature	150	°C
P_D	Power dissipation ⁴⁾		mW
	SOT23-5	500	
	DIP8	1250	
	DIP14	1560	
	SO8	710	
	SO14	830	
	TSSOP8	625	
TSSOP14	710		
ESD	Human Body Model	2	kV
	Machine Model	200	V
	Latch-up Immunity	Class A	
	Lead Temperature (soldering, 10 sec)	250	°C

1. All voltages values, except differential voltage are with respect to network terminal.
2. Differential voltages are non-inverting input terminal with respect to the inverting input terminal.
3. The magnitude of input and output voltages must never exceed $V_{CC} + 0.3V$.
4. Short-circuits can cause excessive heating and destructive dissipation. P_D is calculated with $T_{amb} = +25^\circ C$, $T_j = +150^\circ C$ and
 $R_{thja} = 250^\circ C/W$ for SOT23-5 package
 $= 100^\circ C/W$ for DIP8 package
 $= 80^\circ C/W$ for DIP14 package
 $= 175^\circ C/W$ for SO8 package
 $= 150^\circ C/W$ for SO14 package
 $= 200^\circ C/W$ for TSSOP8 package
 $= 175^\circ C/W$ for TSSOP14 package

OPERATING CONDITIONS

Symbol	Parameter	Value	Unit
V_{CC}	Supply Voltage	2.7 to 10	V
V_{icm}	Common Mode Input Voltage Range	$V_{CC}^- - 0.3$ to $V_{CC}^+ + 0.3$	V
T_{oper}	Operating Free Air Temperature Range	-40 to + 85	°C

ELECTRICAL CHARACTERISTICS $V_{CC} = +2.7V$ $T_{amb} = 25^{\circ}C$ (unless otherwise specified)

Symbol	Parameter	Min.	Typ.	Max.	Unit
V_{io}	Input Offset Voltage TS861/2/4 $T_{min} < T < T_{max}$		3	15 18	mV
	TS861/2/4A $T_{min} < T < T_{max}$		3	7 10	
ΔV_{io}	Input Offset Voltage Drift		6		$\mu V/^{\circ}C$
I_{io}	Input Offset Current ¹⁾ $T_{min} < T < T_{max}$		1	150 300	pA
I_{ib}	Input Bias Current ¹⁾ $T_{min} < T < T_{max}$		1	300 600	pA
V_{OH}	High Level Output Voltage $I_{source} = 2.5mA$ $T_{min} < T < T_{max}$	2.35 2.15	2.45		V
V_{OL}	Low Level Output Voltage $I_{sink} = 2.5mA$ $T_{min} < T < T_{max}$		0.2	0.35 0.45	V
A_{vd}	Large Signal Voltage Gain ²⁾		240		dB
CMR	Common Mode Rejection Ratio $0 < V_{ICM} < 2.7V$		65		dB
SVR	Supply Voltage Rejection Ratio $0 < V_{CC} < 10V$		80		dB
I_{CC}	Supply current per comparator no load, output low no load, output high		6 8	12 14	μA
T_{plh}	Propagation delay from output low to output high $V_{ICM} = 1.35V$, $f = 10kHz$, $C_L = 50pF$ overdrive = 10mV overdrive = 100mV		1.5 0.6		μs
T_{phl}	Propagation delay from output high to output low $V_{ICM} = 1.35V$, $f = 10kHz$, $C_L = 50pF$ overdrive = 10mV overdrive = 100mV		1.5 0.5		μs
T_f	Fall time $f = 10kHz$, $C_L = 50pF$, overdrive = 100mV		20		ns
T_r	Rise time $f = 10kHz$, $C_L = 50pF$, overdrive = 100mV		20		ns

1. Maximum values including unavoidable inaccuracies of the industrial test.

2. Design evaluation

3. Limits are 100% production tested at 25°C. Limits over temperature are guaranteed through correlation and by design.

ELECTRICAL CHARACTERISTICS

$V_{CC} = +5V$

$T_{amb} = 25^{\circ}C$ (unless otherwise specified)

Symbol	Parameter	Min.	Typ.	Max.	Unit
V_{io}	Input Offset Voltage TS861/2/4 $T_{min} < T < T_{max}$		3	15 18	mV
	TS861/2/4A $T_{min} < T < T_{max}$		3	7 10	
ΔV_{io}	Input Offset Voltage Drift		6		$\mu V/^{\circ}C$
I_{io}	Input Offset Current ¹⁾ $T_{min} < T < T_{max}$		1	150 300	pA
I_{ib}	Input Bias Current ¹⁾ $T_{min} < T < T_{max}$		1	300 600	pA
V_{OH}	High Level Output Voltage $I_{source} = 5mA$ $T_{min} < T < T_{max}$	4.6 4.45	4.8		V
V_{OL}	Low Level Output Voltage $I_{sink} = 5mA$ $T_{min} < T < T_{max}$		0.2	0.4 0.55	V
A_{vd}	Large Signal Voltage Gain ²⁾		240		dB
CMR	Common Mode Rejection Ratio $0 < V_{ICM} < 5V$		70		dB
SVR	Supply Voltage Rejection Ratio $2.7 < V_{CC} < 10V$		80		dB
I_{CC}	Supply current per comparator no load, output low no load, output high		6 8	12 14	μA
T_{plh}	Propagation delay from output low to output high $V_{ICM} = 2.5V$, $f = 10kHz$, $C_L = 50pF$ overdrive = 10mV overdrive = 100mV		2 0.5		μs
T_{phl}	Propagation delay from output high to output low $V_{ICM} = 2.5V$, $f = 10kHz$, $C_L = 50pF$ overdrive = 10mV overdrive = 100mV		2 0.4		μs
T_f	Fall time $f = 10kHz$, $C_L = 50pF$, overdrive = 100mV		20		ns
T_r	Rise time $f = 10kHz$, $C_L = 50pF$, overdrive = 100mV		20		ns

1. Maximum values including unavoidable inaccuracies of the industrial test..

2. Design evaluation

3. Limits are 100% production tested at 25°C. Limits over temperature are guaranteed through correlation and by design

ELECTRICAL CHARACTERISTICS**V_{CC} = +10V**T_{amb} = 25°C (unless otherwise specified)

Symbol	Parameter	Min.	Typ.	Max.	Unit
V _{io}	Input Offset Voltage (V _{ICM} = V _{CC} / 2) TS861/2/4 Tmin<T<Tmax		3	15 18	mV
ΔV _{io}	Input Offset Voltage Drift		6		μV/°C
I _{io}	Input Offset Current ¹⁾ Tmin<T<Tmax		1	150 300	pA
I _{ib}	Input Bias Current ¹⁾ Tmin<T<Tmax		1	300 600	pA
V _{OH}	High Level Output Voltage I _{source} =5mA Tmin<T<Tmax	9.6 9.45	9.8		V
V _{OL}	Low Level Output Voltage I _{sink} =5mA Tmin<T<Tmax		0.2	0.4 0.55	V
A _{vd}	Large Signal Voltage Gain ²⁾		240		dB
CMR	Common Mode Rejection Ratio 0 < V _{ICM} < 10V		75		dB
SVR	Supply Voltage Rejection Ratio 2.7 < V _{CC} < 10V		80		dB
I _{CC}	Supply current per comparator no load, output low no load, output high		7 10	14 16	μA
T _{plh}	Propagation delay from output low to output high V _{ICM} =5V, f=10kHz, C _L =50pF overdrive = 10mV overdrive = 100mV		3 0.5		μs
T _{phl}	Propagation delay from output high to output low V _{ICM} =5V, f=10kHz, C _L =50pF overdrive = 10mV overdrive = 100mV		2.6 0.4		μs
T _f	Fall time f=10kHz, C _L =50pF, overdrive=100mV		20		ns
T _r	Rise time f=10kHz, C _L =50pF, overdrive=100mV		20		ns

1. Maximum values including unavoidable inaccuracies of the industrial test.

2. Design evaluation

3. Limits are 100% production tested at 25°C. Limits over temperature are guaranteed through correlation and by design.

V_{IO} versus V_{ICM} at $V_{CC}= 2.7V$

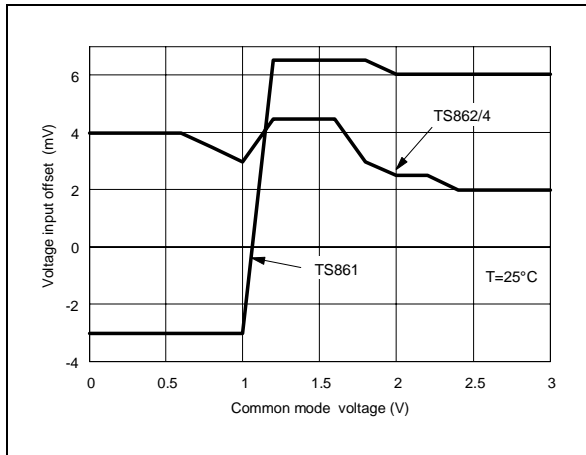

V_{IO} versus V_{ICM} and temperature at $V_{CC}= 2.7V$

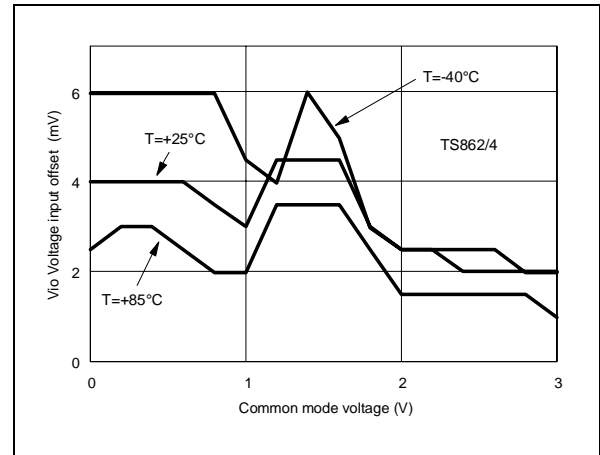

V_{IO} versus V_{ICM} at $V_{CC}= 5V$

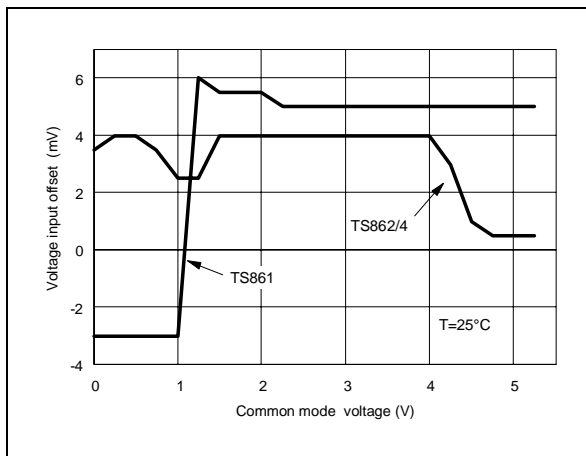

V_{IO} versus V_{ICM} and temperature at $V_{CC}= 5V$

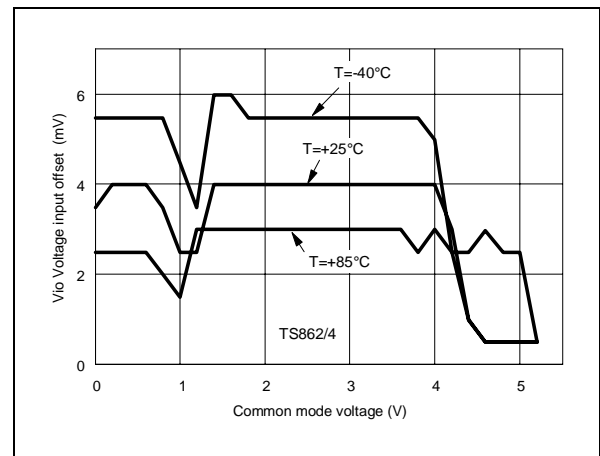

V_{IO} versus V_{ICM} at $V_{CC}= 10V$

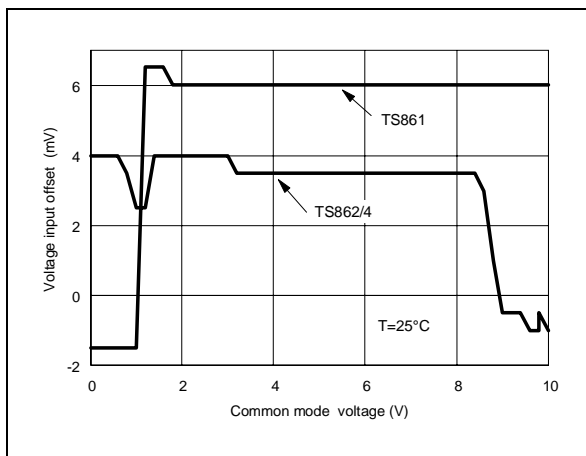

V_{IO} versus V_{ICM} and temperature at $V_{CC}= 10V$

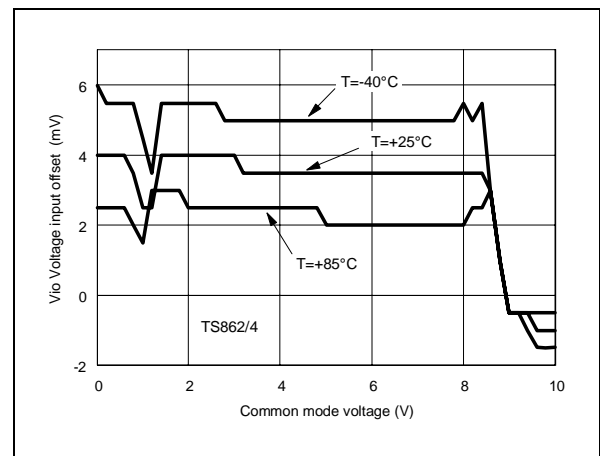

V_{IO} versus V_{CC} at $V_{ICM} = V_{CC} / 2$

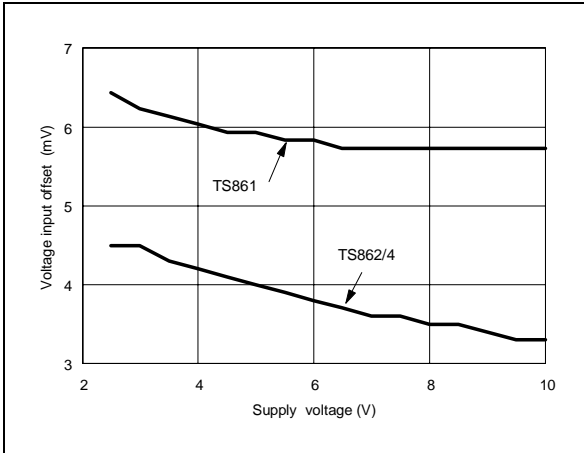

V_{IO} versus temperature at $V_{CC} = 5V$

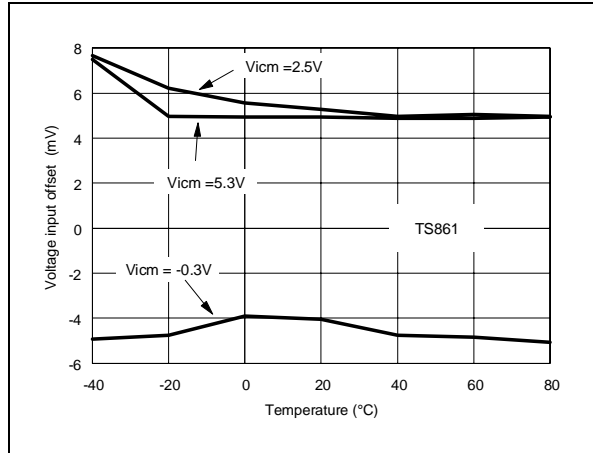

Supply Current (I_{CC}) vs Supply Voltage (V_{CC})

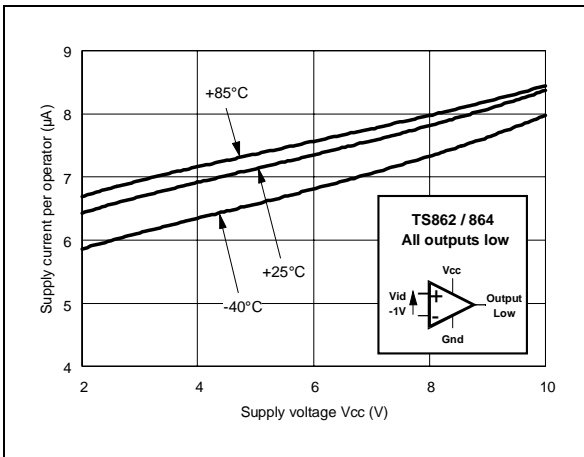

Supply Current (I_{CC}) vs Supply Voltage (V_{CC})

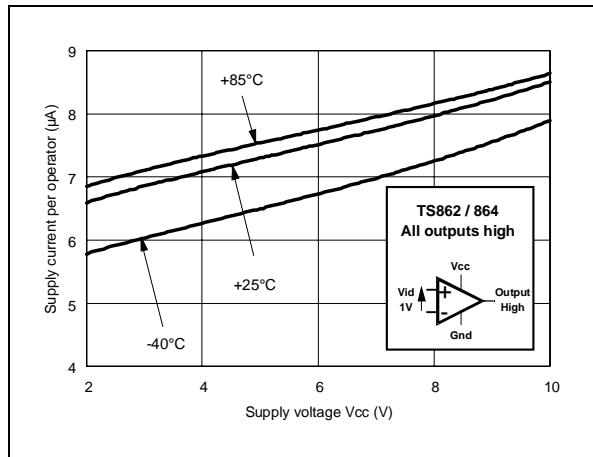

Supply Current (I_{CC}) vs Temperature

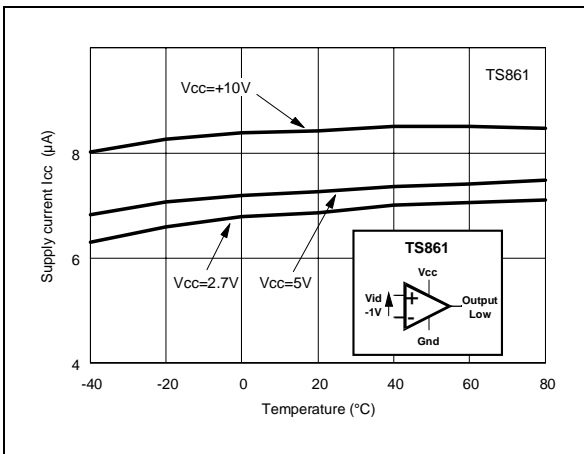

Supply Current (I_{CC}) vs Temperature

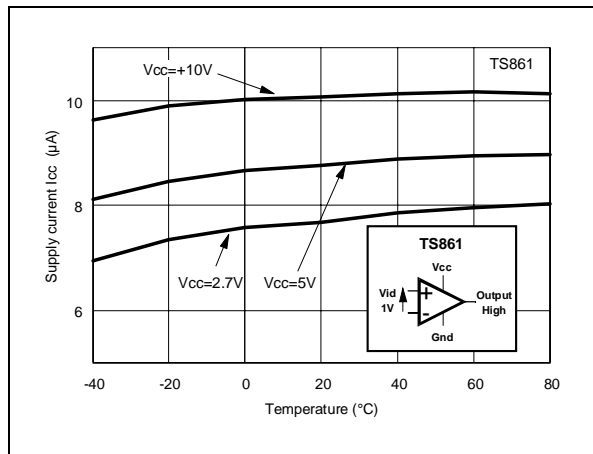

V_{OL} versus I_{SINK} and temperature at $V_{CC}=5V$

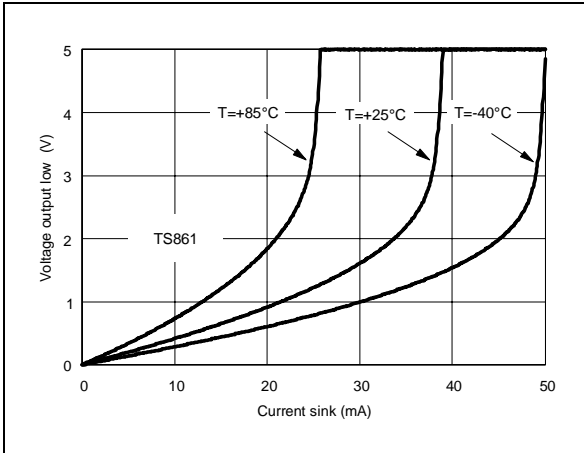

V_{OH} vs I_{SOURCE} and temperature at $V_{CC}=5V$

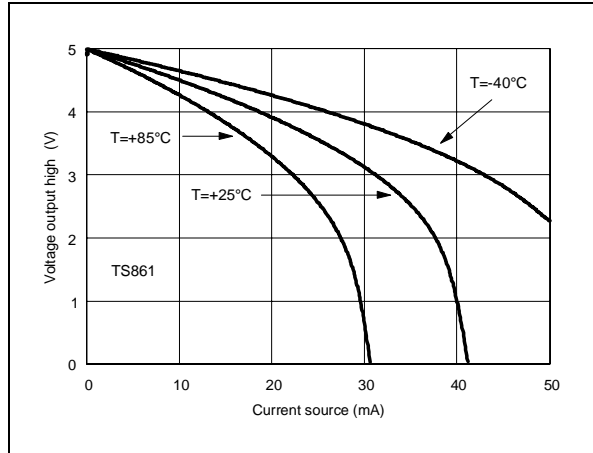

Response time T_{PHL} at $V_{CC}= 2.7V$

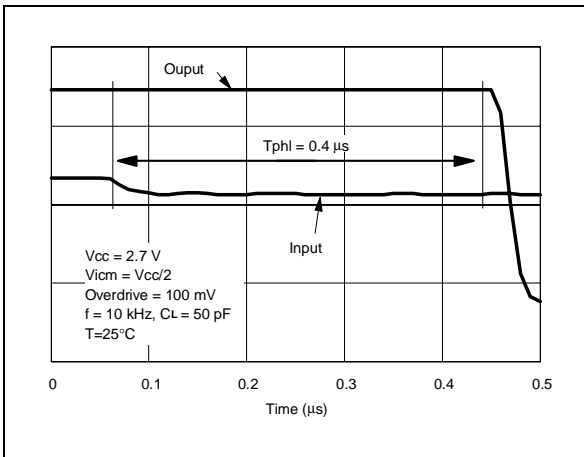

Response time T_{PLH} at $V_{CC}= 2.7V$

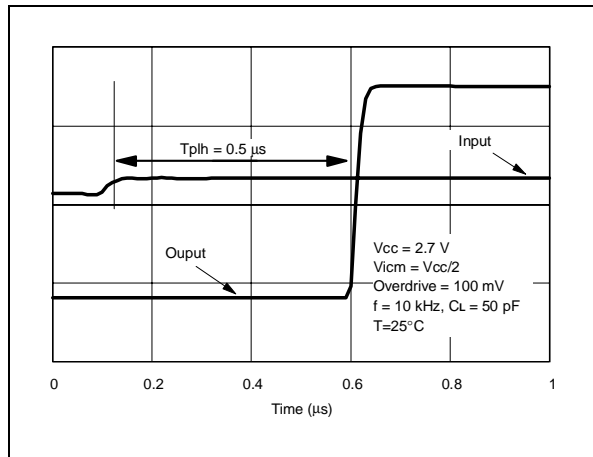

Response time T_{PHL} at $V_{CC}= 5V$

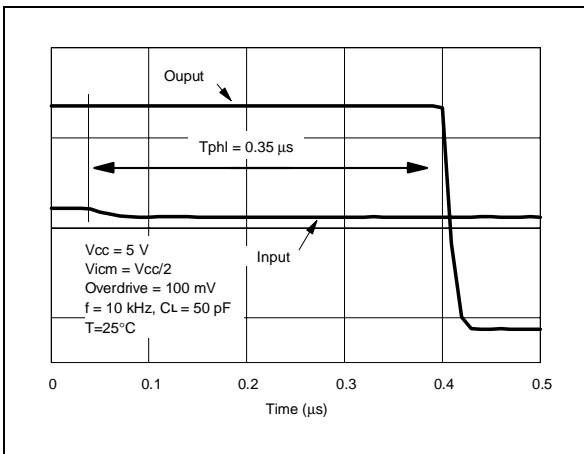

Response time T_{PLH} at $V_{CC}= 5V$

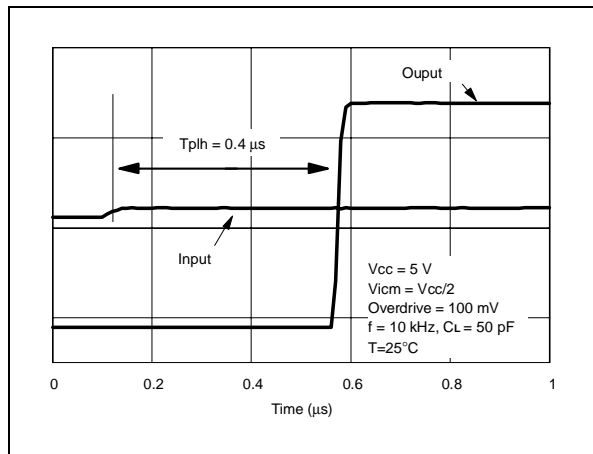

TS861IN - TS862IN

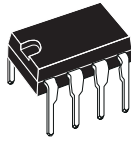

PACKAGE MECHANICAL DATA
8 PINS - PLASTIC PACKAGE

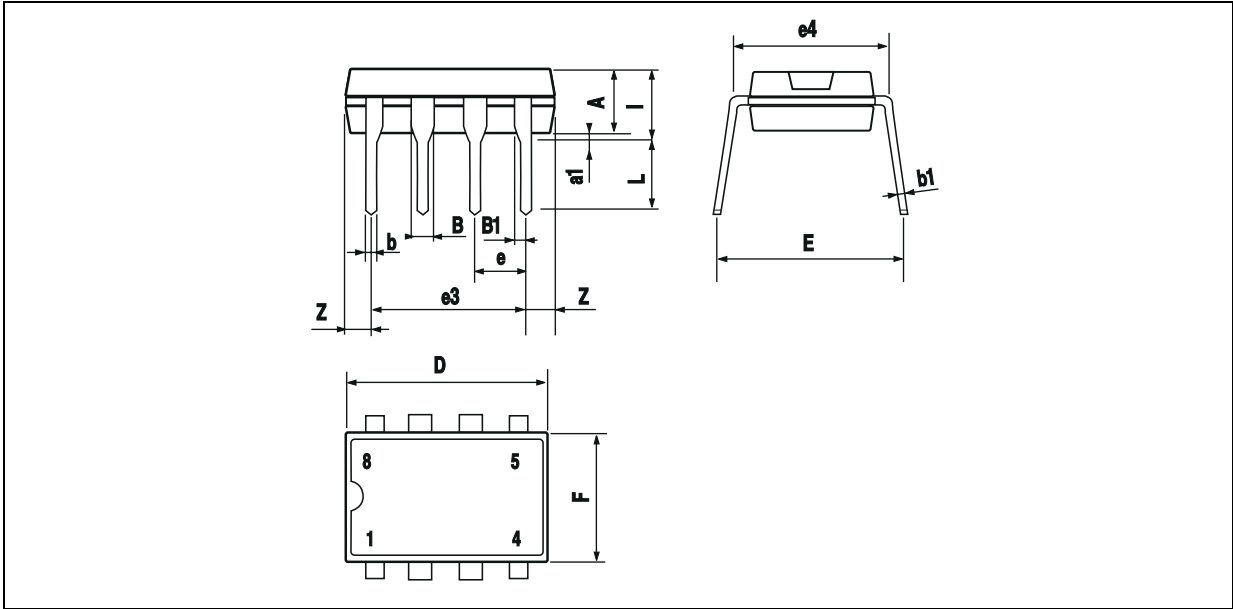

Dimensions	Millimeters			Inches		
	Min.	Typ.	Max.	Min.	Typ.	Max.
A		3.32			0.131	
a1	0.51			0.020		
B	1.15		1.65	0.045		0.065
b	0.356		0.55	0.014		0.022
b1	0.204		0.304	0.008		0.012
D			10.92			0.430
E	7.95		9.75	0.313		0.384
e		2.54			0.100	
e3		7.62			0.300	
e4		7.62			0.300	
F			6.6			0.260
i			5.08			0.200
L	3.18		3.81	0.125		0.150
Z			1.52			0.060

TS861ID - TS862ID

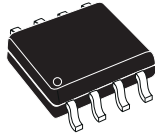

PACKAGE MECHANICAL DATA
8 PINS - PLASTIC MICROPACKAGE (SO)

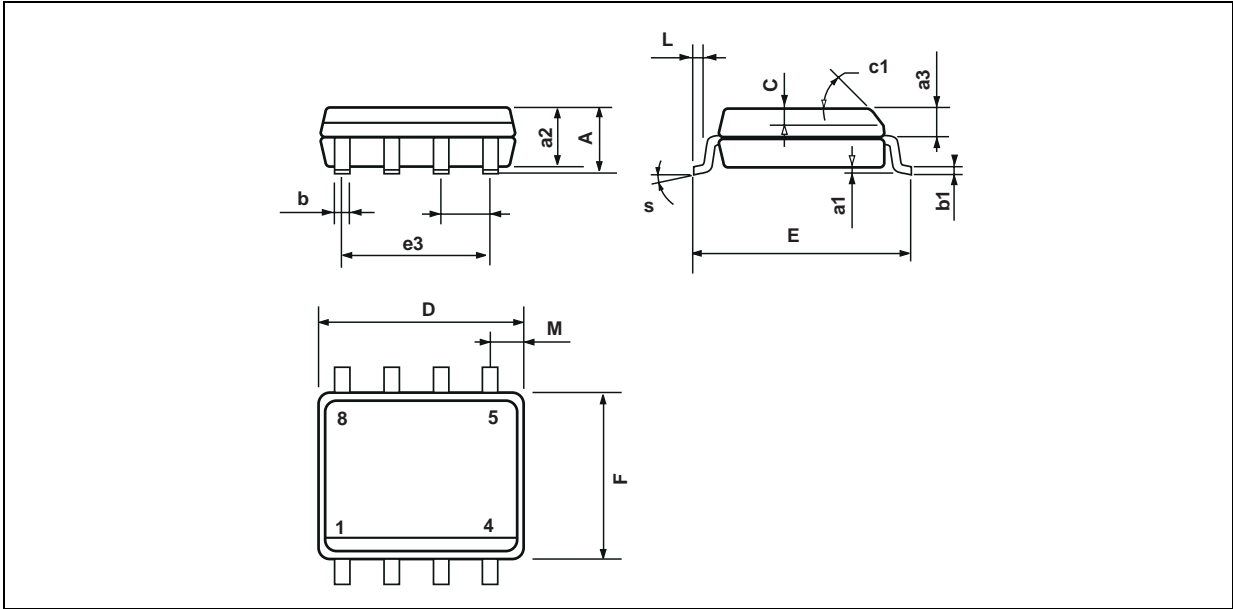

Dimensions	Millimeters			Inches		
	Min.	Typ.	Max.	Min.	Typ.	Max.
A			1.75			0.069
a1	0.1		0.25	0.004		0.010
a2			1.65			0.065
a3	0.65		0.85	0.026		0.033
b	0.35		0.48	0.014		0.019
b1	0.19		0.25	0.007		0.010
C	0.25		0.5	0.010		0.020
c1	45° (typ.)					
D	4.8		5.0	0.189		0.197
E	5.8		6.2	0.228		0.244
e		1.27			0.050	
e3		3.81			0.150	
F	3.8		4.0	0.150		0.157
L	0.4		1.27	0.016		0.050
M			0.6			0.024
S	8° (max.)					

TS862IPT

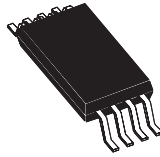

PACKAGE MECHANICAL DATA
8 PINS - THIN SHRINK SMALL OUTLINE PACKAGE

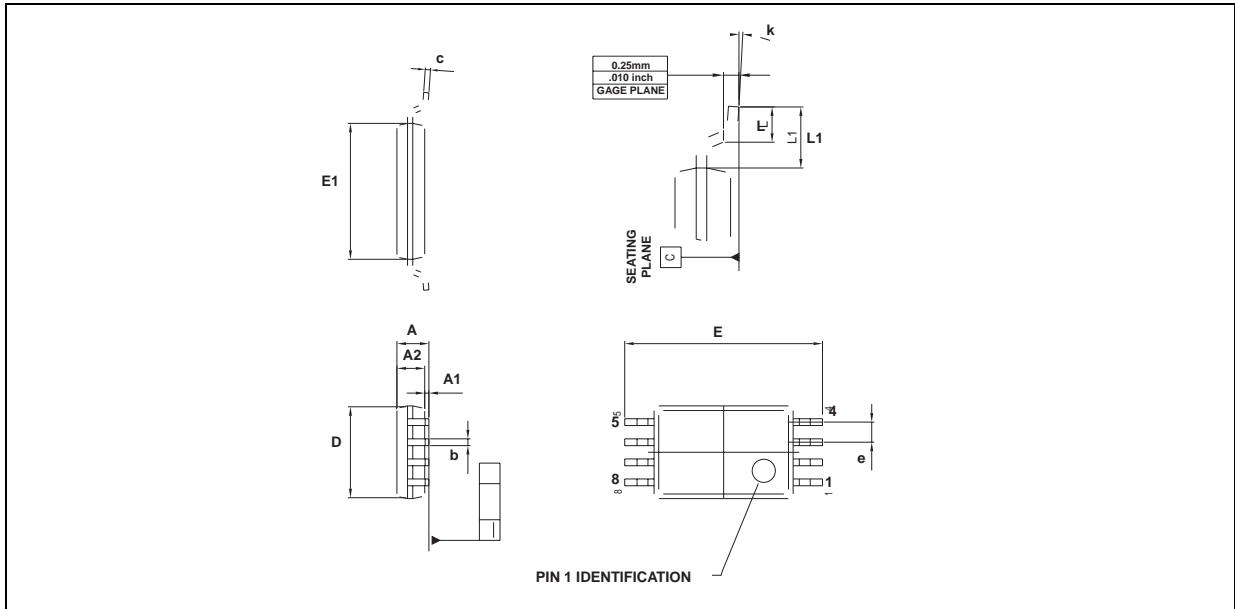

Dimensions	Millimeters			Inches		
	Min.	Typ.	Max.	Min.	Typ.	Max.
A			1.20			0.05
A1	0.05		0.15	0.01		0.006
A2	0.80	1.00	1.05	0.031	0.039	0.041
b	0.19		0.30	0.007		0.15
c	0.09		0.20	0.003		0.012
D	2.90	3.00	3.10	0.114	0.118	0.122
E		6.40			0.252	
E1	4.30	4.40	4.50	0.169	0.173	0.177
e		0.65			0.025	
k	0°		8°	0°		8°
l	0.50	0.60	0.75	0.09	0.0236	0.030
L	0.45	0.600	0.75	0.018	0.024	0.030
L1		1.000			0.039	

TS864IN

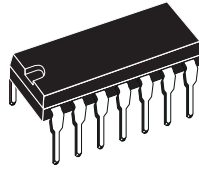

PACKAGE MECHANICAL DATA

14 PINS - PLASTIC PACKAGE

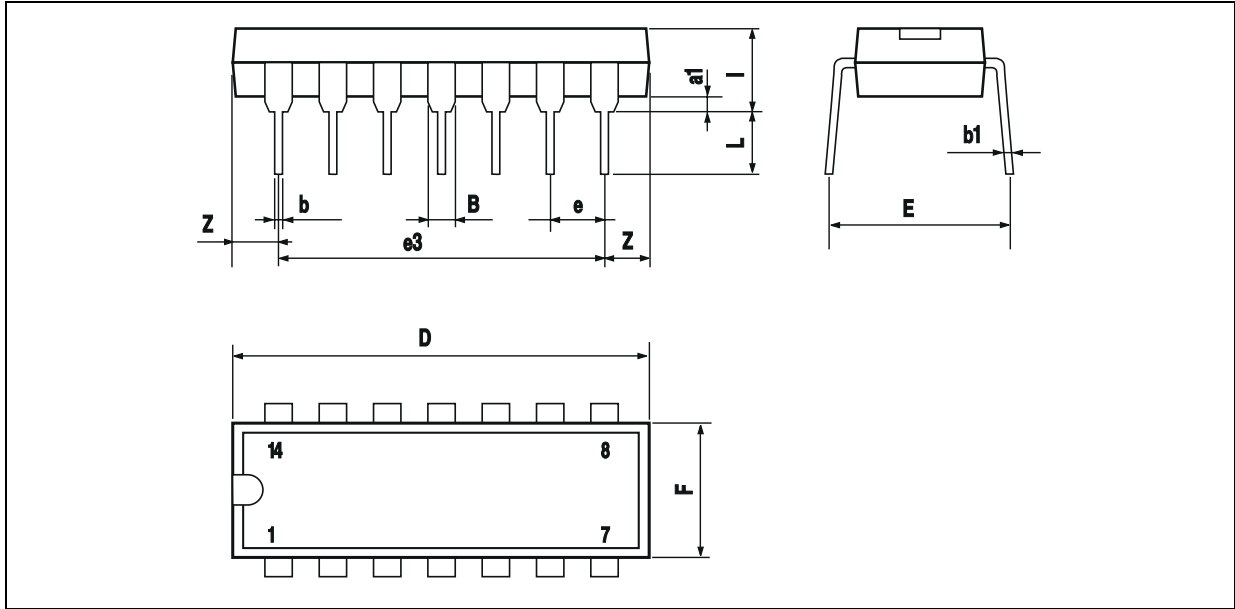

Dimensions	Millimeters			Inches		
	Min.	Typ.	Max.	Min.	Typ.	Max.
a1	0.51			0.020		
B	1.39		1.65	0.055		0.065
b		0.5			0.020	
b1		0.25			0.010	
D			20			0.787
E		8.5			0.335	
e		2.54			0.100	
e3		15.24			0.600	
F			7.1			0.280
i			5.1			0.201
L		3.3			0.130	
Z	1.27		2.54	0.050		0.100

TS864ID

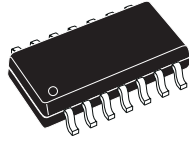

PACKAGE MECHANICAL DATA
14 PINS - PLASTIC MICROPACKAGE (SO)

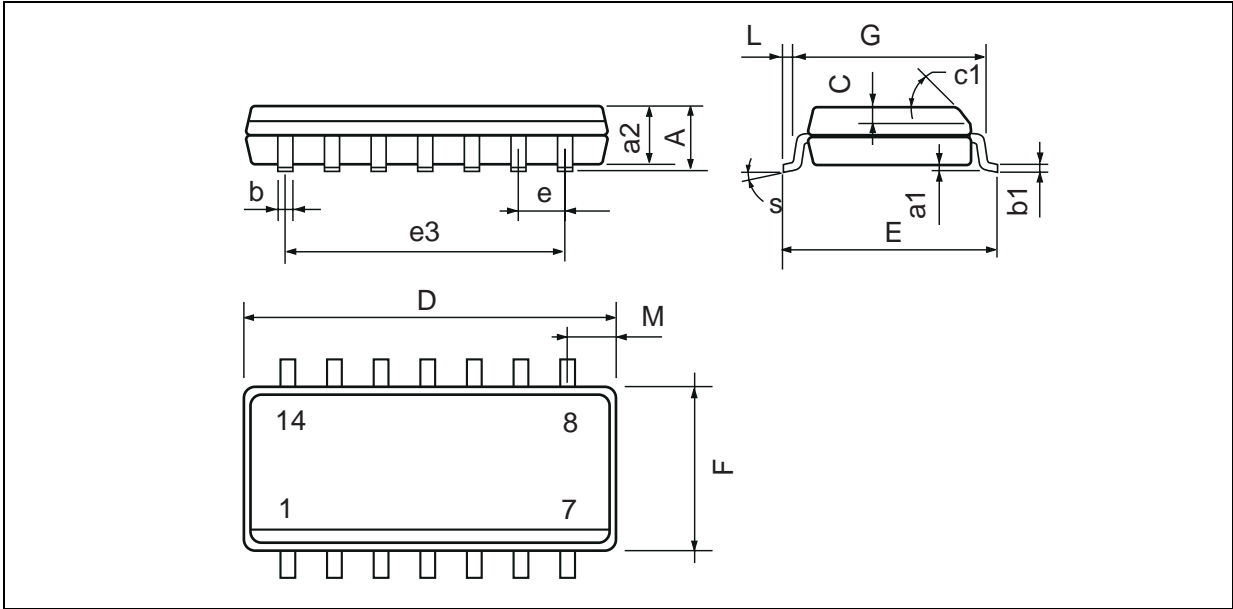

Dimensions	Millimeters			Inches		
	Min.	Typ.	Max.	Min.	Typ.	Max.
A			1.75			0.069
a1	0.1		0.2	0.004		0.008
a2			1.6			0.063
b	0.35		0.46	0.014		0.018
b1	0.19		0.25	0.007		0.010
C		0.5			0.020	
c1	45° (typ.)					
D (1)	8.55		8.75	0.336		0.344
E	5.8		6.2	0.228		0.244
e		1.27			0.050	
e3		7.62			0.300	
F (1)	3.8		4.0	0.150		0.157
G	4.6		5.3	0.181		0.208
L	0.5		1.27	0.020		0.050
M			0.68			0.027
S	8° (max.)					

Note : (1) D and F do not include mold flash or protrusions - Mold flash or protrusions shall not exceed 0.15mm (.066 inc) ONLY FOR DATA BOOK.

TS864IPT

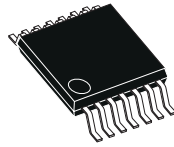

PACKAGE MECHANICAL DATA

14 PINS - THIN SHRINK SMALL OUTLINE PACKAGE

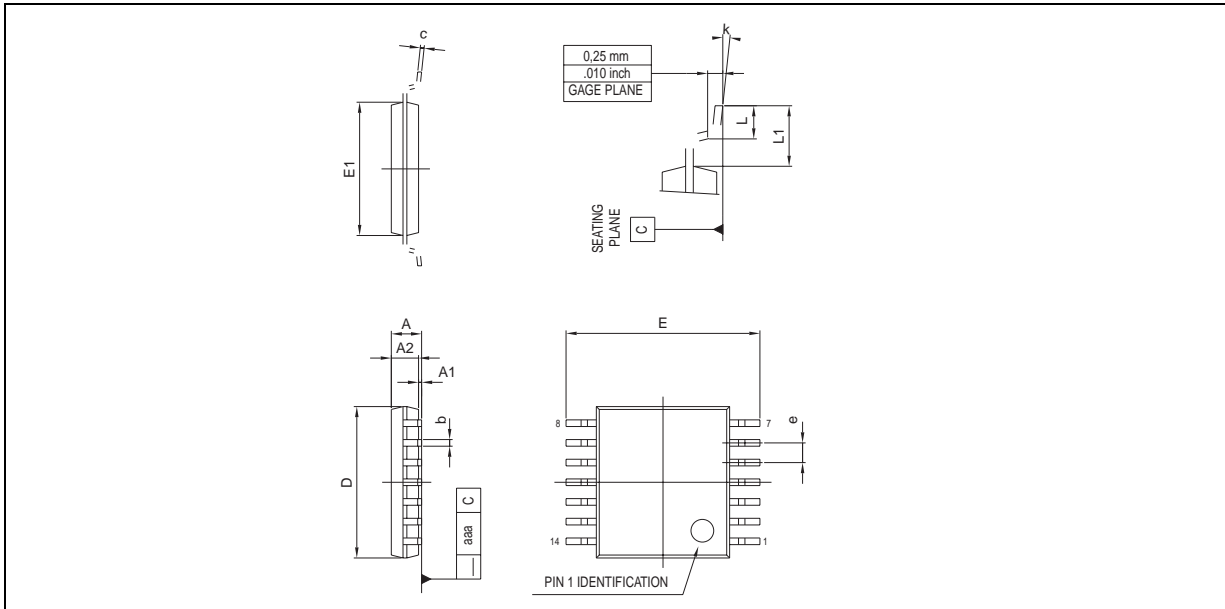

Dimensions	Millimeters			Inches		
	Min.	Typ.	Max.	Min.	Typ.	Max.
A			1.20			0.05
A1	0.05		0.15	0.01		0.006
A2	0.80	1.00	1.05	0.031	0.039	0.041
b	0.19		0.30	0.007		0.15
c	0.09		0.20	0.003		0.012
D	4.90	5.00	5.10	0.192	0.196	0.20
E		6.40			0.252	
E1	4.30	4.40	4.50	0.169	0.173	0.177
e		0.65			0.025	
k	0°		8°	0°		8°
L	0.450	0.600	0.750	0.018	0.024	0.030
L1		1.00			0.039	
aaa			0.100			0.004

TS861ILT



PACKAGE MECHANICAL DATA
5 PINS - TINY PACKAGE (SOT23)

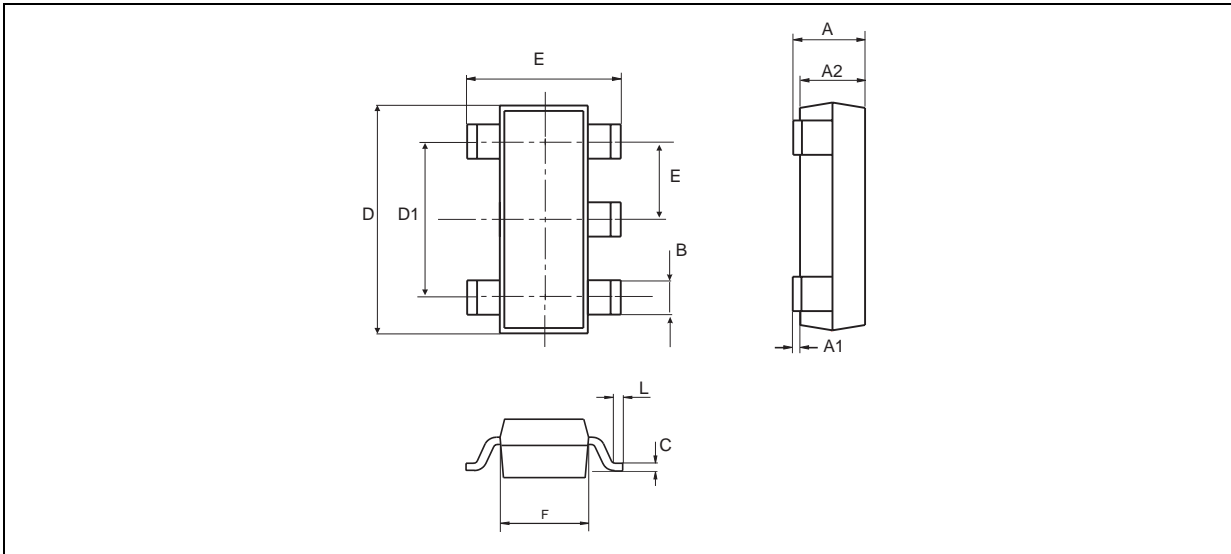

Dimensions	Millimeters			Inches		
	Min.	Typ.	Max.	Min.	Typ.	Max.
A	0.90	1.20	1.45	0.035	0.047	0.057
A1	0		0.15			0.006
A2	0.90	1.05	1.30	0.035	0.041	0.051
B	0.35	0.40	0.50	0.014	0.016	0.020
C	0.09	0.15	0.20	0.004	0.006	0.008
D	2.80	2.90	3.00	0.110	0.114	0.118
D1		1.90			0.075	
e		0.95			0.037	
E	2.60	2.80	3.00	0.102	0.110	0.118
F	1.50	1.60	1.75	0.059	0.063	0.069
L	0.3	0.5	0.60	0.012	0.014	0.024
K	0d		10d	0d		10d

Information furnished is believed to be accurate and reliable. However, STMicroelectronics assumes no responsibility for the consequences of use of such information nor for any infringement of patents or other rights of third parties which may result from its use. No license is granted by implication or otherwise under any patent or patent rights of STMicroelectronics. Specifications mentioned in this publication are subject to change without notice. This publication supersedes and replaces all information previously supplied. STMicroelectronics products are not authorized for use as critical components in life support devices or systems without express written approval of STMicroelectronics.

© The ST logo is a registered trademark of STMicroelectronics

© 2002 STMicroelectronics - Printed in Italy - All Rights Reserved
STMicroelectronics GROUP OF COMPANIES

Australia - Brazil - Canada - China - Finland - France - Germany - Hong Kong - India - Israel - Italy - Japan - Malaysia
Malta - Morocco - Singapore - Spain - Sweden - Switzerland - United Kingdom - United States

© <http://www.st.com>



This datasheet has been download from:

www.datasheetcatalog.com

Datasheets for electronics components.